

> SW2/A

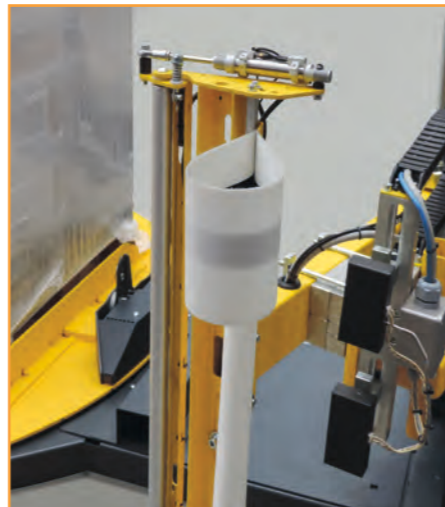

SW2/A with Optional Welding Pad & Stand Alone Control Panel



PLC & touchscreen HMI

Welding pad option available on SW2/A with PLC: this feature allows perfect film tail management by welding film tail after cutting and spreading. Pallets with zero-tails specification.

This option is supplied packaged with cut & attach system, PLC, HMI control panel, remote radio control (optional) and safety fences according to CE rules. Additionally PLC allows to design customized working cycles according to your needs.

	Ø	L	W	H	KG max
SW2/A-L	1650	1200	1000	2100	2000
SW2/A-M	1650	1200	1000	2600	2000
SW2/A-H	1650	1200	1000	3000	2000

> Reclining column hinged to the base

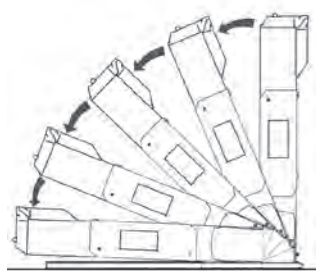

> Film roll dimensions

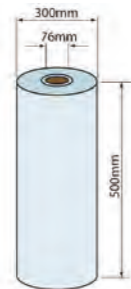

> Pallet dimensions

SW2	L	W	H	KG max
Ø 1500	1200	800	2100/2600/3000	2000
Ø 1650	1200	1000	2100/2600/3000	2000
Ø 1800	1200	1200	2100/2600/3000	2000
SW2-HS	L	W	H	KG max
Ø 1500	1200	800	2100/2600/3000	1200



> Machine shown with safety fences and anti-intrusion barriers

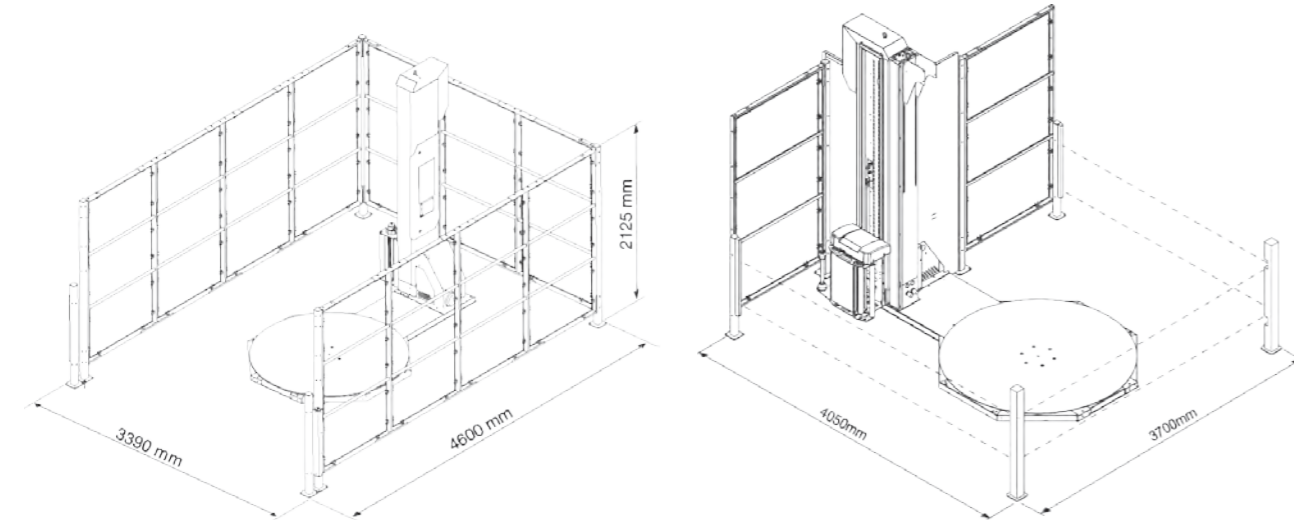

Cod.pubbli.:SBC0028684



SW2 range

Semi Automatic Stretch Wrapper

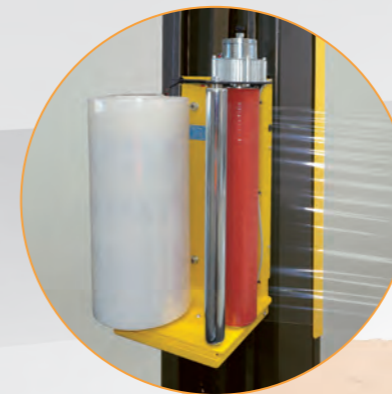

Different film carriages available



Helio International Engineering Corp.

Tel: +886-2-8696 1000 Fax: +886-2-8696 1008

25F., No.96, Sec. 1, Xintai 5th Rd., Xizhi Dist., New Taipei City
22102, Taiwan
www.helio-global.com



for more details:



SW2

SW2 is a Semi-Automatic Stretch Wrapper.

SW2 model is a semi-automatic machine for wrapping palletized loads with stretch film. Turntable soft start function, manual or automatic mode and film pallet over-lap adjustable. Can be equipped with mechanical / electromagnetic brake or powered prestretch carriages. High-end machine for intensive and demanding stretch film applications able to optimize film usage and to grant full control of all wrapping parameters.

Key Features

- Platform diameter: 1650 mm
- Max pallet height: 2100 mm
- Max loading weight: 2000 Kgs
- Different sizes as option
- Belt driven carriage
- Film carriage with clutch (mechanical or electromagnetic - M/FM) or pre-stretch (motorized up to 300% - PW)
- Safety switch under film carriage
- Turntable speed adjustable by Inverter/ Soft Start & Fix Stop
- Carriage speed adjustable by inverter
- Control panel with advanced options and possibility to store up to 10 programs
- Turntable blocking feature to avoid movements during loading/unloading operations
- Photocell to detect pallet height
- Hinged column to turntable frame to facilitate machine installation and mobility
- Two forklift access point for machine easy repositioning

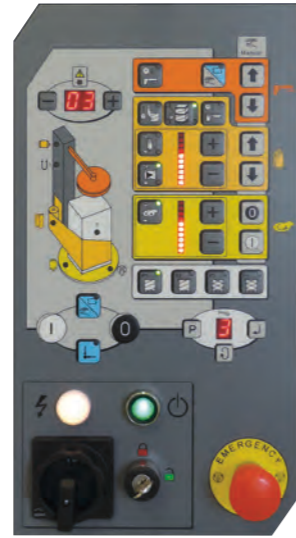

Standard control panel



Optional touchscreen HMI with PLC

Optionals

Integrated weighing system



Turntable diameter 1500 mm - 1200 kg. max



Burial frame



Loading ramp



Pressing unit for unstable pallet available for all models

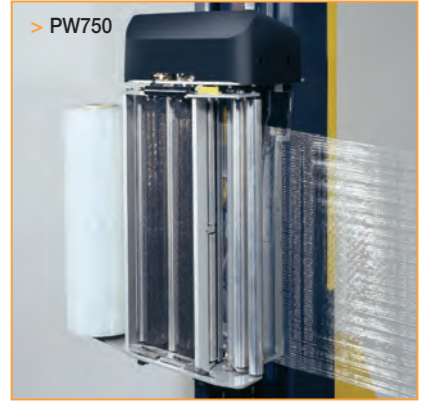
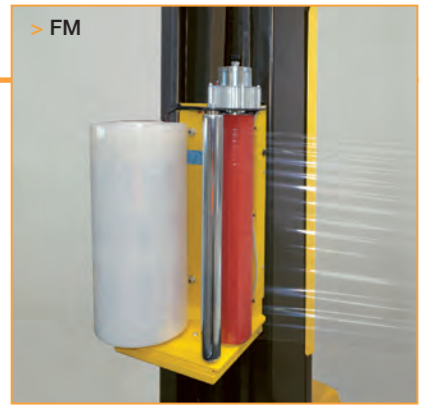
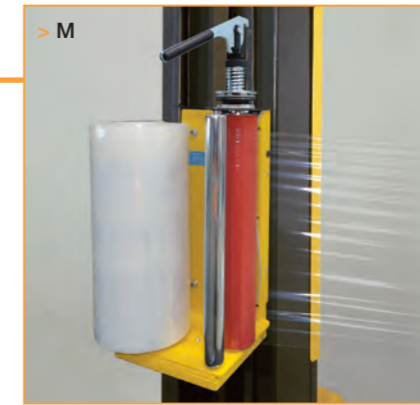
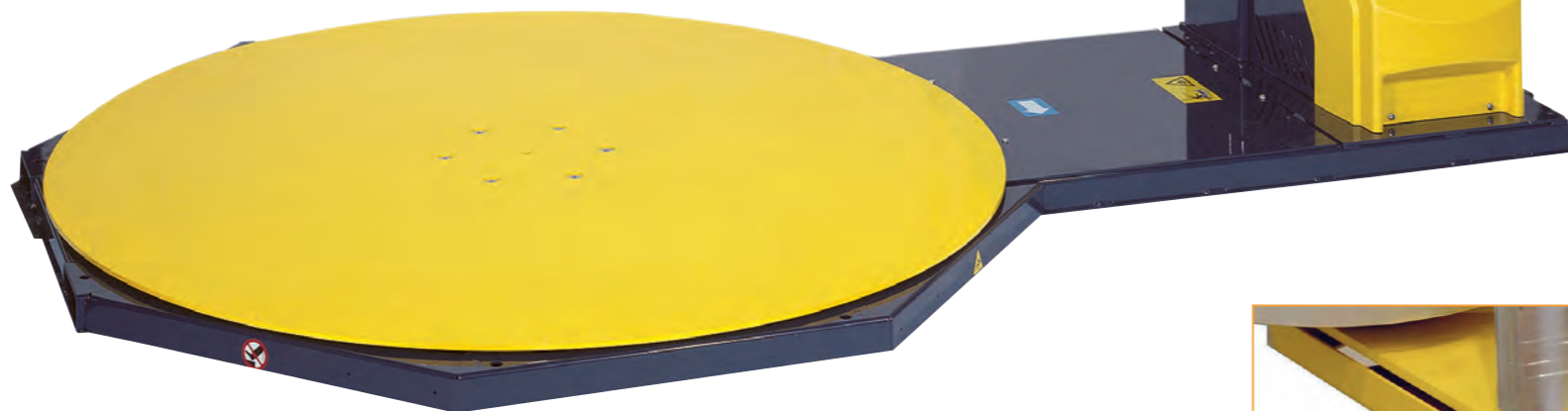

- M Mechanical brake
- FM Electromagnetic brake
- SM Mechanical pre-stretch 30-60-90%
- PW Powered prestretch 150-200-250%
- PW750 Powered prestretch 150-200-250% (other ratio on request)



Carriage for net/mesh

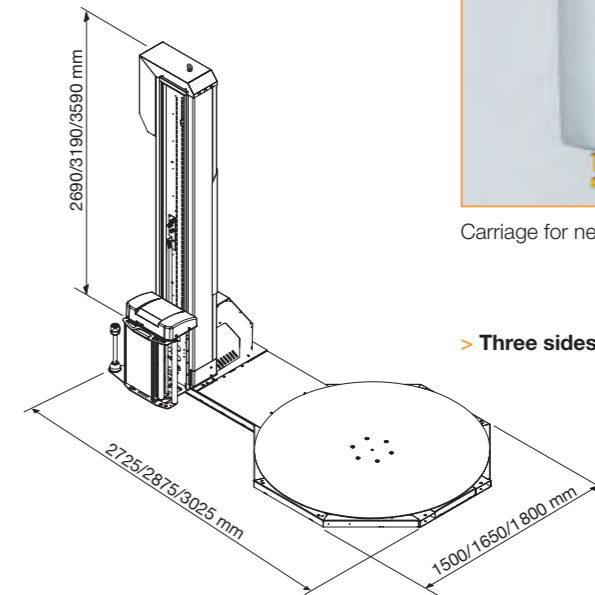

> Three sides accessibility

- SW2-L pallet height 2100
- SW2-M pallet height 2600
- SW2-H pallet height 3000

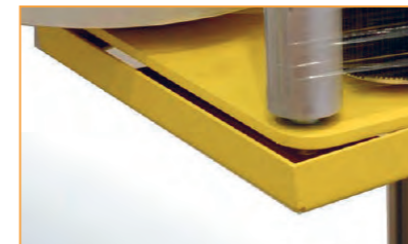

Safety device under carriage



Photocell for black film or colored products



Electric panel heater for environment temperatures from -5 °C to +5 °C



other languages: www.helio-global.com

